



ELECTROSTATIC SENSITIVE DEVICE
OBSERVE HANDLING PRECAUTIONS

MITSUBISHI RF POWER MOS FET

RD100HHF1

Silicon MOSFET Power Transistor 30MHz,100W

DESCRIPTION

RD100HHF1 is a MOS FET type transistor specifically designed for HF High power amplifiers applications.

FEATURES

- High power and High Gain:
Pout>100W, Gp>11.5dB @Vdd=12.5V,f=30MHz
- High Efficiency: 60%typ.on HF Band

APPLICATION

For output stage of high power amplifiers in HF Band mobile radio sets.

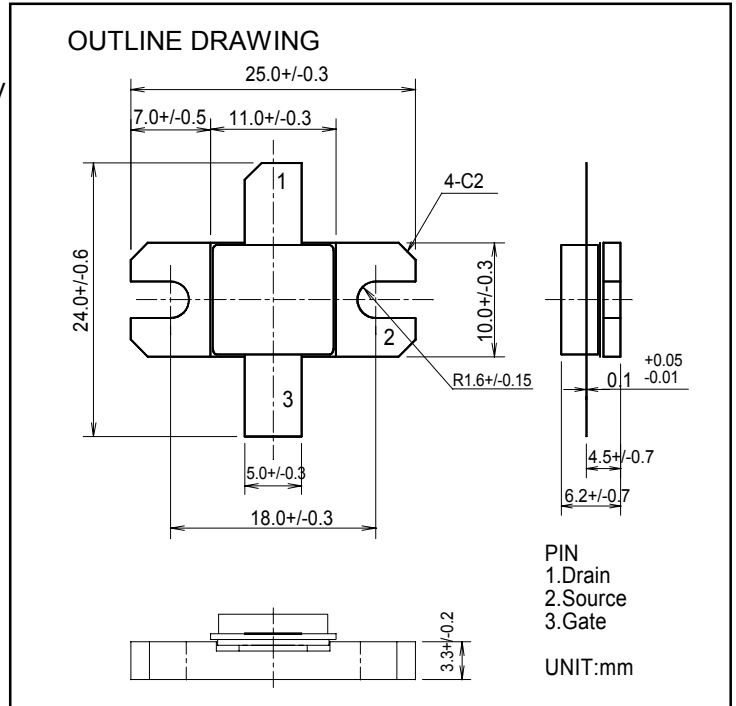

ABSOLUTE MAXIMUM RATINGS

(Tc=25°C UNLESS OTHERWISE NOTED)

SYMBOL	PARAMETER	CONDITIONS	RATINGS	UNIT
VDSS	Drain to source voltage		50	V
VGSS	Gate to source voltage		+/-20	V
Pch	Channel dissipation	Tc=25°C	176.5	W
Tj	Junction temperature		175	°C
Tstg	Storage temperature		-40 to +175	°C
Rth-c	Thermal resistance	Junction to case	0.85	°C/W

Note 1: Above parameters are guaranteed independently.

ELECTRICAL CHARACTERISTICS (Tc=25°C UNLESS OTHERWISE NOTED)

SYMBOL	PARAMETER	CONDITIONS	LIMITS			UNIT
			MIN	TYP	MAX.	
IDSS	Zero gate voltage drain current	VDS=17V, VGS=0V	-	-	10	µA
IGSS	Gate to source leak current	VGS=10V, VDS=0V	-	-	1	µA
VTH	Gate threshold voltage	VDS=12V, IDS=1mA	1	-	5	V
Pout	Output power	f=30MHz, VDD=12.5V	100	110	-	W
ηD	Drain efficiency	Pin=7W, Idq=1.0A	55	60	-	%
	Load VSWR tolerance	VDD=15.2V, Po=100W(PinControl) Idq=1.0A, Zg=50Ω Load VSWR=20:1(All Phase)	No destroy			-

Note : Above parameters , ratings , limits and conditions are subject to change.



ELECTROSTATIC SENSITIVE DEVICE
OBSERVE HANDLING PRECAUTIONS

MITSUBISHI RF POWER MOS FET
RD100HHF1

Silicon MOSFET Power Transistor 30MHz,100W

TYPICAL CHARACTERISTICS

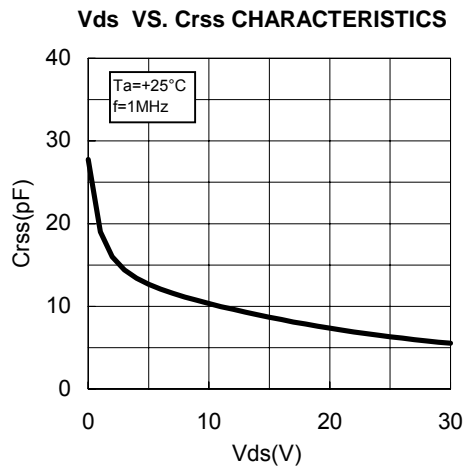
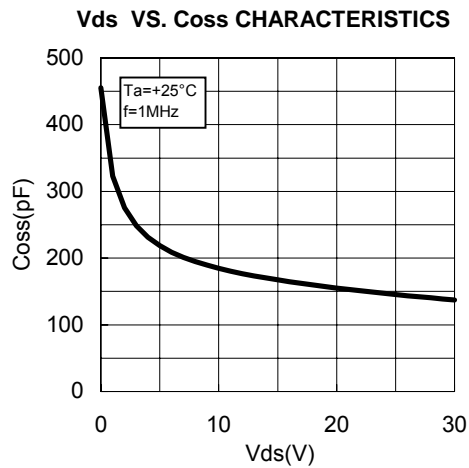
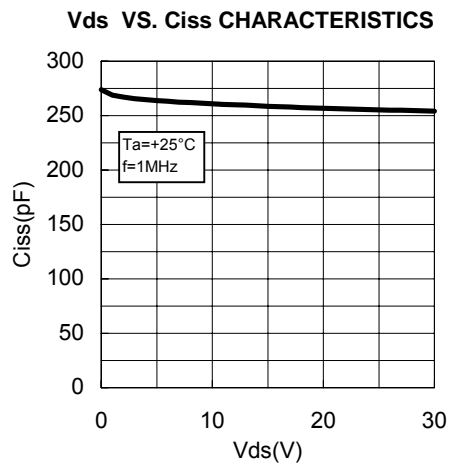
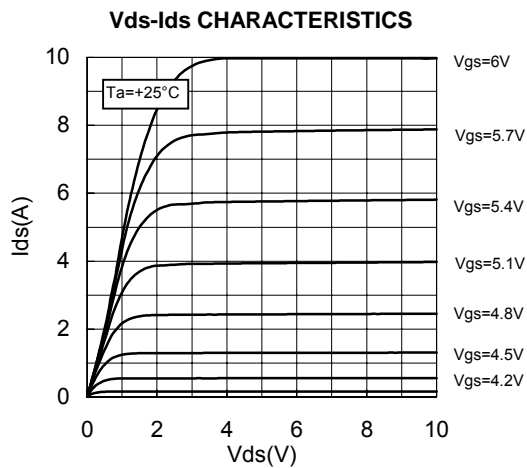
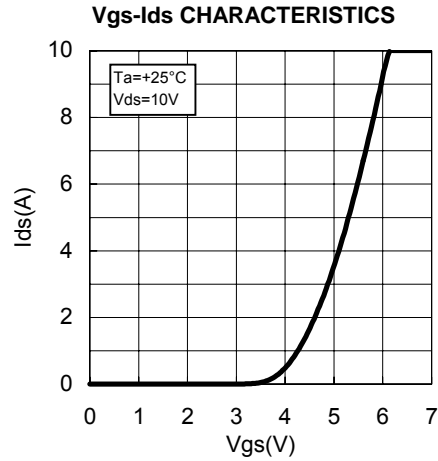
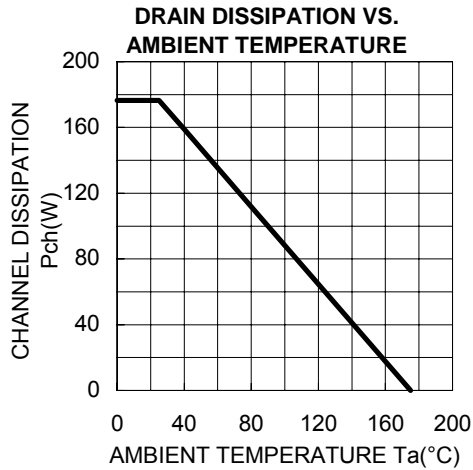



ELECTROSTATIC SENSITIVE DEVICE
OBSERVE HANDLING PRECAUTIONS

MITSUBISHI RF POWER MOS FET
RD100HHF1

Silicon MOSFET Power Transistor 30MHz,100W

TYPICAL CHARACTERISTICS

Pin-Po CHARACTERISTICS

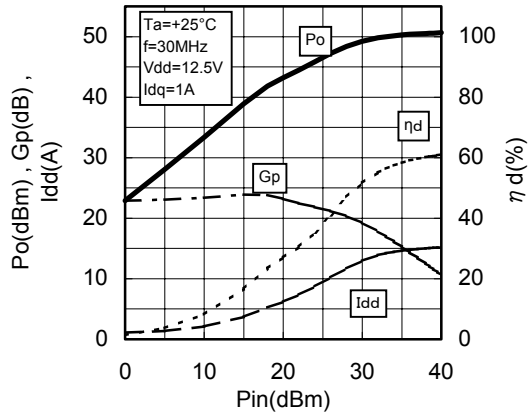

Pin-Po CHARACTERISTICS

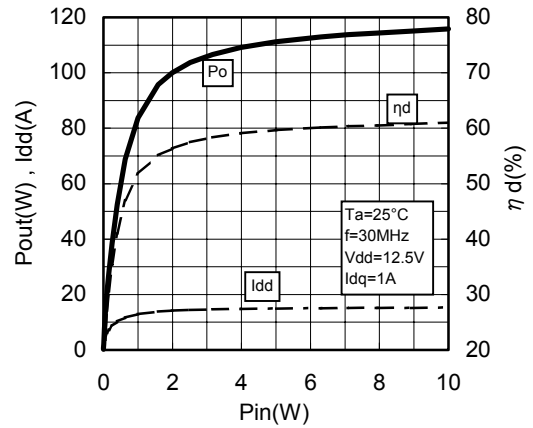

Vdd-Po CHARACTERISTICS

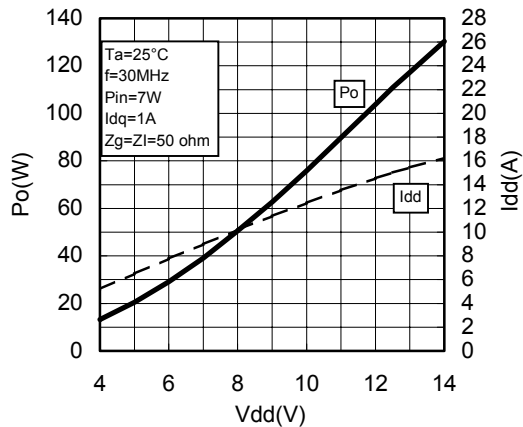

Vgs-Ids CHARACTERISTICS 2 +25°C

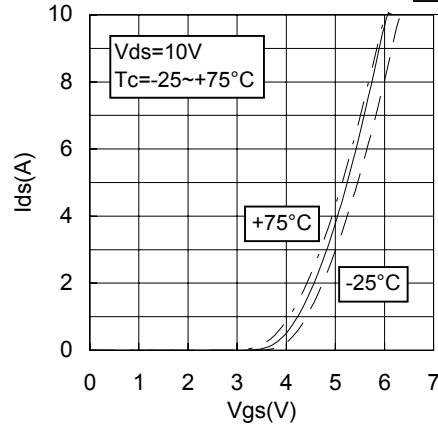

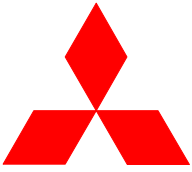

ELECTROSTATIC SENSITIVE DEVICE
OBSERVE HANDLING PRECAUTIONS

MITSUBISHI RF POWER MOS FET RD100HHF1

Silicon MOSFET Power Transistor 30MHz,100W

Test Circuit

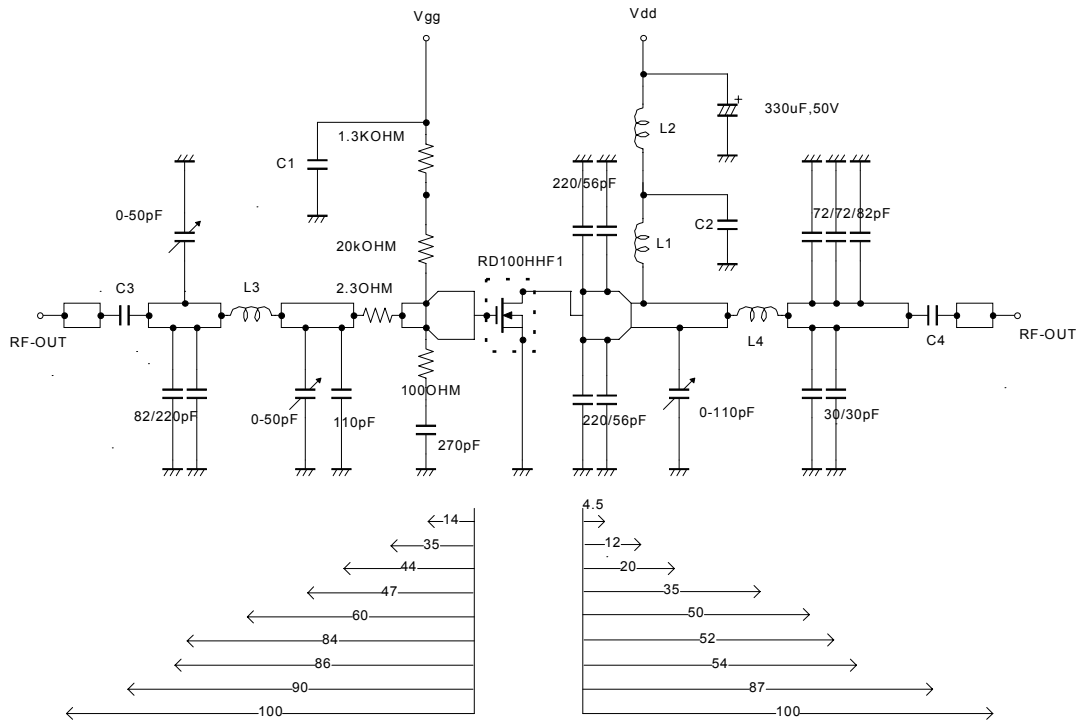

- C1:330pF*3,0.022uF in parallel
- C2:33uF*2,220pF in parallel
- C3:68pF,82pF in parallel
- C4:15pF,18pF in parallel

- L1:7Turns,I.D10mm,D1.5mm P=2 silver plated copper wire
- L2:10Turns,I.D10mm,D1.5mm P=2 silver plated copper wire
- L3:4Turns,I.D4mm,D1.5mm P=3 silver plated copper wire
- L4:4Turns,I.D4mm,D1.5mm P=3 silver plated copper wire

Dimensions:mm

Note:Board material-glass epoxy substrate

Micro strip line width=4.2mm/50OHM,er:2.7,t:1.6mm



ELECTROSTATIC SENSITIVE DEVICE
OBSERVE HANDLING PRECAUTIONS

MITSUBISHI RF POWER MOS FET
RD100HHF1

Silicon MOSFET Power Transistor 30MHz,100W

INPUT/OUTPUT IMPEDANCE VS.FREQUENCY CHARACTERISTICS

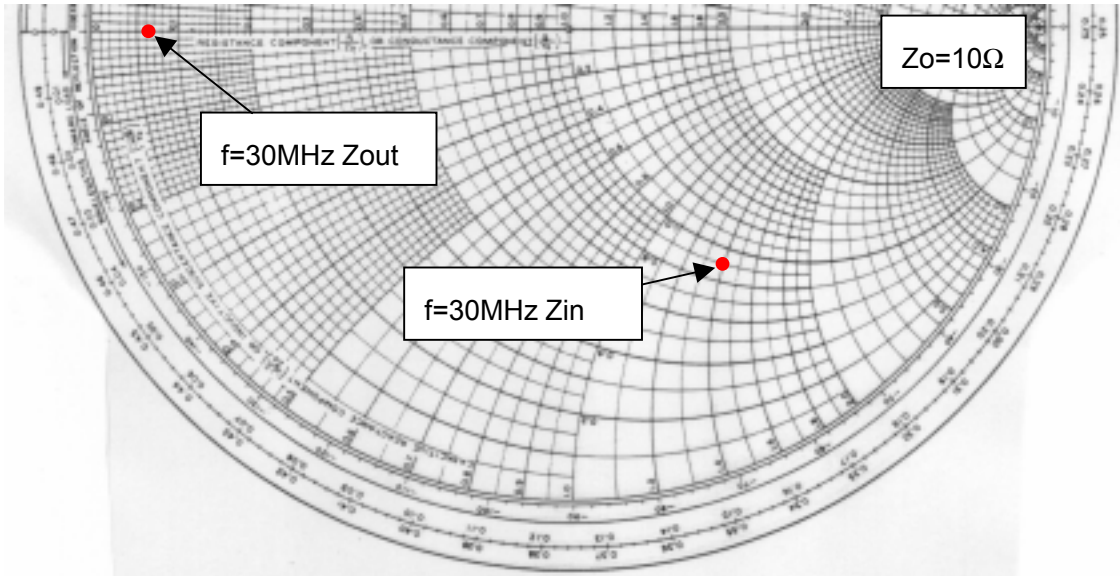

Zin , Zout

f	Zin	Zout	Conditions
(MHz)	(ohm)	(ohm)	
30	8.86-j14.31	0.64-j0.01	Po=115W, Vdd=12.5V, Pin=7W



ELECTROSTATIC SENSITIVE DEVICE
OBSERVE HANDLING PRECAUTIONS

MITSUBISHI RF POWER MOS FET
RD100HHF1

Silicon MOSFET Power Transistor 30MHz,100W

RD100HHF1 S-PARAMETER DATA (@V_{dd}=12.5V, I_d=800mA)

Freq. [MHz]	S11		S21		S12		S22	
	(mag)	(ang)	(mag)	(ang)	(mag)	(ang)	(mag)	(ang)
10	0.835	-158.6	31.451	94.8	0.014	5.2	0.770	-162.1
30	0.839	-171.1	10.628	79.3	0.014	-9.9	0.764	-171.6
50	0.849	-172.9	6.212	71.0	0.012	-20.7	0.786	-171.4
100	0.886	-173.9	2.749	54.1	0.012	-34.1	0.842	-171.4
150	0.915	-175.1	1.541	40.2	0.009	-27.8	0.880	-173.6
200	0.932	-176.4	0.972	31.6	0.007	-36.9	0.908	-174.3
250	0.945	-177.3	0.671	24.5	0.006	-54.4	0.946	-176.2
300	0.951	-178.2	0.481	20.1	0.005	-30.4	0.941	-177.4
350	0.958	-179.3	0.365	15.2	0.003	13.1	0.952	-178.3
400	0.960	-179.8	0.291	13.4	0.003	-18.0	0.974	-179.8
450	0.964	179.5	0.243	8.5	0.004	45.3	0.963	179.6
500	0.966	178.7	0.195	6.8	0.003	42.3	0.971	178.6
550	0.970	178.2	0.154	5.2	0.004	78.6	0.975	177.5
600	0.967	177.5	0.133	4.8	0.005	80.1	0.965	176.8
650	0.971	177.0	0.119	1.0	0.003	72.0	0.972	176.0
700	0.970	176.5	0.109	-1.3	0.006	61.3	0.973	175.1
750	0.969	175.6	0.092	0.6	0.007	67.2	0.964	174.9
800	0.970	175.2	0.080	-4.0	0.005	82.2	0.974	173.9
850	0.976	174.5	0.073	-1.9	0.007	78.7	0.969	173.3
900	0.973	173.9	0.067	-5.4	0.008	69.9	0.973	172.6
950	0.973	173.2	0.058	4.1	0.008	86.8	0.973	171.5
1000	0.977	172.6	0.049	-8.7	0.011	78.7	0.971	171.7



ELECTROSTATIC SENSITIVE DEVICE
OBSERVE HANDLING PRECAUTIONS

MITSUBISHI RF POWER MOS FET
RD100HHF1

Silicon MOSFET Power Transistor 30MHz,100W

Keep safety first in your circuit designs!

Mitsubishi Electric Corporation puts the maximum effort into making semiconductor products better and more reliable, but there is always the possibility that trouble may occur with them. Trouble with semiconductors may lead to personal injury, fire or property damage. Remember to give due consideration to safety when making your circuit designs, with appropriate measures such as (i) placement of substitutive, auxiliary circuits, (ii) use of non-flammable material or (iii) prevention against any malfunction or mishap.